

# SENNEBOGEN 613

- 13.5t pick & carry Capability enclosed
- Climatised cabin
- Maxicab tilt cabin

- 15.0t
- 20.0m boom
- 25.0m with fly jib

- Rubber tracks
- Load moment indicator system
- Hydraulic extendable undercarriage
- 3/1 Fall hook block



The Sennebogen 613 has a 18.8m robust 3-section telescopic boom that can be used under load - even on rough terrain. A 15 tonne capacity make it simple to use and easy to transport. Consider the possibilities...

# SPECIFICATIONS SUPERCRAANE

# SENNEBOGEN 613

## DIMENSIONS

Length	8501mm
Width	3000mm Retracted 4000mm Extended
Height	2921mm
Weight	22000kg

## CAPACITY

Max. capacity	15000kg at 2.0m
Max. working radius (main boom)	1100kg at 17.3m
Max. working radius (fly jib)	700kg at 20.0m
Max. lifting height (main boom)	19.0m
Max. lifting height (fly jib)	24.0m

## TRACK

Width	700mm
-------	-------

## MIN. TRANSPORT WIDTH

Overall Track	3000mm
Overall Unit	3000mm

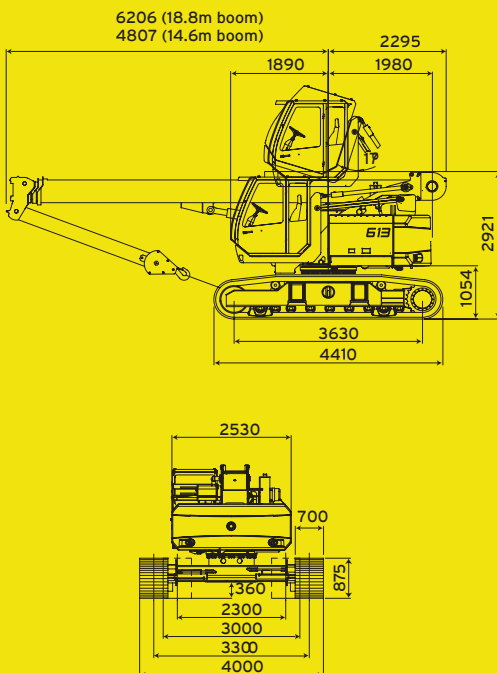

## WORKING RANGE

### BOOM 9-30M

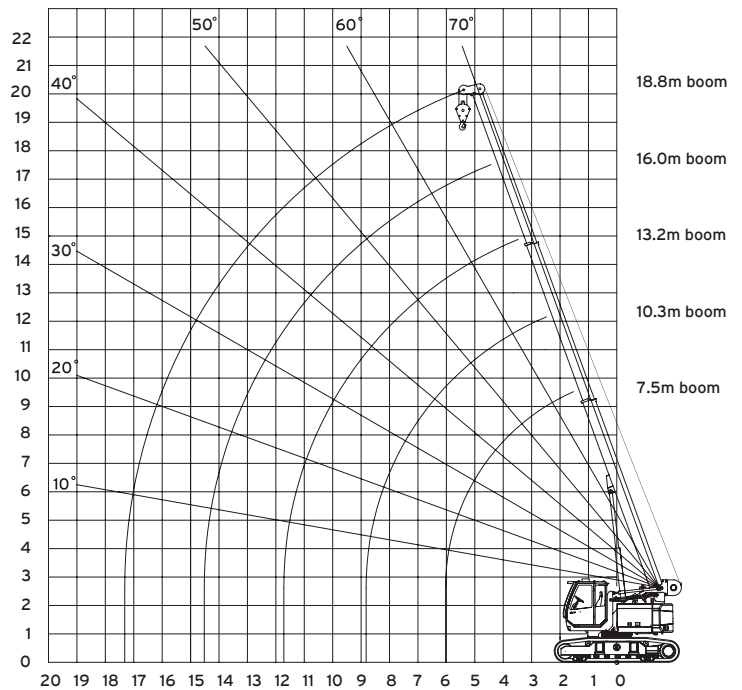

### FOLDING JIB 5M

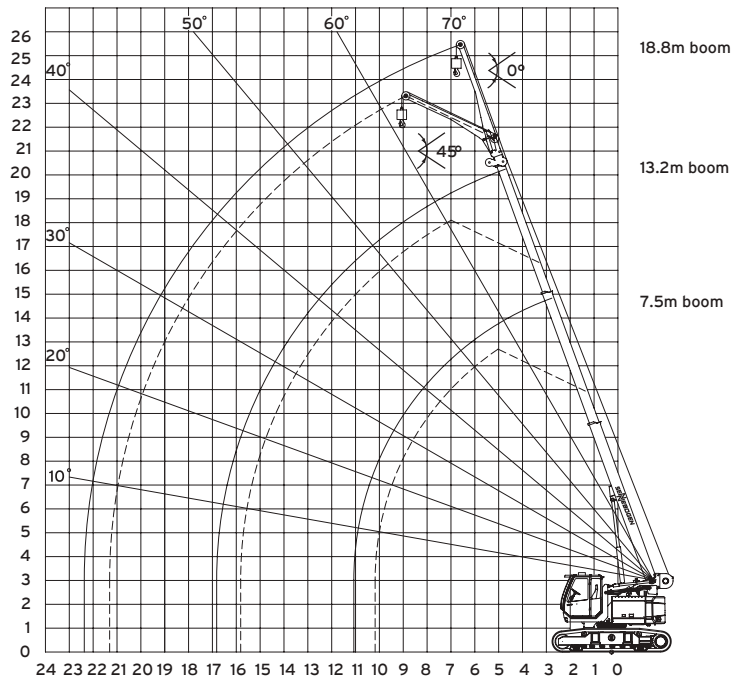





# LOAD CHART

# SENNEBOGEN 613

## 5M FOLDING JIB LOAD CHART

18.8m main boom, 5 jib, crawler retracted

### TOTAL RATED LOAD

	7.5m Boom		10.3m Boom		13.2m Boom		16.0m Boom		18.8m Boom	
Working Radius (m)	Total Rated Load (t)		Total Rated Load (t)		Total Rated Load (t)		Total Rated Load (t)		Total Rated Load (t)	
										
	0°	45°	0°	45°	0°	45°	0°	45°	0°	45°
2.0										
4.0	3.8		4.4							
5.0	3.3		3.8		4.0					
6.0	2.9	2.0	3.1		3.0		3.0			
7.0	2.5	1.9	2.4	2.0	2.4		2.3		2.3	
8.0	2.1	1.9	2.0	2.0	1.9	1.9	1.9		1.8	
9.0	1.7	1.7	1.6	1.6	1.5	1.5	1.5	1.5	1.5	
10.0	1.4		1.3	1.3	1.3	1.3	1.2	1.2	1.2	1.2
11.0			1.1	1.1	1.0	1.0	1.0	1.0	0.9	0.9
12.0			0.9		0.8	0.8	0.8	0.8	0.8	0.8
13.0			0.7		0.7	0.7	0.6	0.6	0.6	0.6
14.0					0.6		0.5	0.5		

The total rated load charts are based on the actual working radius including boom deflection.











# LOAD CHART

# SENNEBOGEN 613

## MAIN BOOM LOAD CHART

18.8m main boom, pick and carry

### TOTAL RATED LOAD

	7.5m Boom		10.3m Boom		13.2m Boom		16.0m Boom		18.8m Boom	
Working Radius (m)	Total Rated Load (t)		Total Rated Load (t)		Total Rated Load (t)		Total Rated Load (t)		Total Rated Load (t)	
										
2.0	13.5	10.8								
3.0	12.0	7.5	9.0	7.6						
4.0	9.5	4.8	9.0	4.8	7.2	4.9				
5.0	7.7	3.3	7.7	3.4	7.2	3.4	5.4	3.5		
5.5	6.8	2.9	6.8	3.1	6.7	3.1	5.4	3.1	4.1	3.1
6.0	5.1/6.0m	2.6/6.0m	6.0	2.6	6.0	2.6	5.3	2.6	4.1	2.6
7.0			4.7	2.1	4.8	2.1	4.7	2.1	4.1	2.1
8.0			3.8	1.6	3.9	1.6	3.9	1.6	3.7	1.7
9.0			3.2/8.8m	1.4/8.8m	3.2	1.4	3.2	1.4	3.2	1.4
10.0					2.7	1.1	2.7	1.1	2.7	1.1
11.0					2.3	0.9	2.3	0.9	2.3	0.9
12.0					2.2/11.6m	0.8/11.6m	2.0	0.7	2.1	0.7
13.0							1.8	0.6	1.8	0.6
14.0							1.5	0.5	1.5	0.5
15.0							1.4/14.4m		1.4	
16.0									1.2	
17.0									1.0/17.3m	











# LOAD CHART

# SENNEBOGEN 613

## MAIN BOOM LOAD CHART

18.8m main boom, stationary

### TOTAL RATED LOAD

	7.5m Boom		10.3m Boom		13.2m Boom		16.0m Boom		18.8m Boom	
Working Radius (m)	Total Rated Load (t)		Total Rated Load (t)		Total Rated Load (t)		Total Rated Load (t)		Total Rated Load (t)	
										
2.0	15.0	12.0								
3.0	13.3	8.3	10.0	8.4						
4.0	10.6	5.3	10.0	5.3	8.0	5.4				
5.0	8.5	3.7	8.6	3.8	8.0	3.8	6.0	3.9		
5.5	7.5	3.2	7.6	3.4	7.4	3.4	6.0	3.4	4.5	3.4
6.0	5.7/6.0m	2.9/6.0m	6.7	2.9	6.7	2.9	5.9	2.9	4.5	2.9
7.0			5.2	2.3	5.3	2.3	5.2	2.3	4.5	2.3
8.0			4.2	1.8	4.3	1.8	4.3	1.8	4.1	1.9
9.0			3.6/8.8m	1.5/8.8m	3.5	1.5	3.6	1.5	3.6	1.5
10.0					3.0	1.2	3.0	1.2	3.0	1.2
11.0					2.6	1.0	2.6	1.0	2.6	1.0
12.0					2.4/11.6m	0.9/11.6m	2.2	0.8	2.3	0.8
13.0							2.0	0.7	2.0	0.7
14.0							1.7	0.6	1.7	0.6
15.0							1.6/14.4m		1.5	
16.0									1.3	
17.0									1.1/17.3m	





# LOAD CHART

# SENNEBOGEN 613

## 5M FOLDING JIB LOAD CHART

18.8m main boom, 5m jib, crawler extended

### TOTAL RATED LOAD

	7.5m Boom		10.3m Boom		13.2m Boom		16.0m Boom		18.8m Boom	
Working Radius (m)	Total Rated Load (t)		Total Rated Load (t)		Total Rated Load (t)		Total Rated Load (t)		Total Rated Load (t)	
										
	0°	45°	0°	45°	0°	45°	0°	45°	0°	45°
4.0	3.8		4.4							
5.0	3.3		3.8		4.2					
6.0	2.9	2.0	3.4		3.8		3.8			
7.0	2.5	1.9	3.1	2.0	3.4		3.5		2.7	
8.0	2.2	1.9	2.8	2.0	3.1	2.0	3.2		2.7	
9.0	2.0	1.8	2.5	1.9	2.8	2.0	2.9	1.9	2.6	
10.0	1.9		2.2	1.9	2.5	1.9	2.6	1.9	2.4	1.8
11.0			2.0	1.8	2.3	1.9	2.4	1.9	2.2	1.7
12.0			1.8		2.2	1.8	2.2	1.9	2.0	1.6
13.0			1.8		2.0	1.8	2.0	1.8	1.9	1.6
14.0					1.7		1.7	1.7	1.7	1.5
15.0					1.5		1.5	1.5	1.4	1.4
16.0					1.4		1.3		1.3	1.3
17.0							1.1		1.1	
18.0							1.0		1.0	
19.0									0.9	
20.0									0.7	