

- ISUZU
AR-4JJ1XASC
Engine

- 16000kg Operating
Weight
- Bucket Digging Force
24.3kN - 5,418lb



The SANY SY155U short tail swing excavator shows what it is capable of, even in confined areas. The compact design with short slewing radius allows for powerful operation even in tight spaces. Thanks to its superior manoeuvrability, you can easily access areas not possible with other machines. Safe, easy entry, plenty of room and full visibility outside - the operator's cab leaves nothing to be desired. The operator can also enjoy a comfortable, fully adjustable air-suspension seat, ergonomic controls and a modern audio system. The automatic climate control and powerful ventilation and heating ensure that the temperature and fresh air levels in the cab are always perfect

SPECIFICATIONS

SANY SY155U

ENGINE

Model	ISUZU AR-4JJ1XASC
Typ	Water-cooled, 4 cylinder, with commonrail and Adblue
Exhaust emissions	Stage V
Rated power	78.5 kW / 1 900 rpm
Max. torque	375 Nm / 1 800 rpm
Displacement	2999 ccm
Batteries	2 x 12V / 120 Ah

SERVICE REFILL CAPACITIES

Fuel tank	210 l
Engine coolant	23.6 l
Engine oil	15 l
Drive (per side)	1.8 l
Adblue	20 l
Hydraulic oil tank	110 l

PERFORMANCE

Swingspeed	12.5 rpm
Max. travel speed	High 5.3 km/h, slow 3.1 km/h
Max. travel force	114 kN
Gradeability	35°
Bucket capacity	0.6 m³
Groundpressure	0.41 kg/cm²
Bucket digging force ISO	103 kN
Arm digging force ISO	67 kN

OPERATING MASS

SY155U	16 000 kg
SY155U weight w/o blade	15 350 kg

RELIEF VALVE SETTINGS

Implement circuit	343 bar
Swing circuit	250 bar
Travel circuit	343 bar
Pilot pressure	39 bar





















HYDRAULIC SYSTEM

Mainpump	2 x variable-piston-pump with electronic positive control
Max. oilflow	2 x 110 l/min
Max. oilflow (AUX 1)	110 l/min
Max. oilflow (AUX 2)	70 l/min
Travelmotor	Variable displacement axial piston motor
Swingmotor	Axial piston motor

UNDER AND UPPER STRUCTURE

Boom length	4 600 mm
Arm length	2 500 mm
Bottomrollers	7
Toprollers	1
Rotation device	Planetary gear reducer driven by an axial piston motor, automatic hydraulic released slewing brake

LIFTING CAPACITIES OF LOWER AND UPPER DOZER BLADE

Load point height	Radius												Digging reach		
	2,0 m		3,0 m		4,0 m		5,0 m		6,0 m		7,0 m		Max.	Meter	
 below															
7,0 m kg			3353	3353									2536	2536	4,3
6,0 m kg			3632	3632	3310	2687							2216	2216	5,4
5,0 m kg			3594	3594	3944	2685	2590	2061					1994	1994	6,1
4,0 m kg		4736	4736	4643	3487	4146	2628	3822	2048				1764	1764	6,3
3,0 m kg		6858	4607	5314	3325	4484	2537	3967	2001				1625	1625	6,9
2,0 m kg		8370	4238	6031	3140	4855	2432	4144	1941	2549	1574		1548	1548	7,1
1,0 m kg		6651	3979	6547	2980	5144	2334	4278	1881	2748	1545		2183	1520	7,1
Ground line kg		6813	3868	6703	2876	5253	2260	4293	1834				2366	1539	6,9
-1,0 m kg	4686	4686	8485	3839	6484	2826	5115	2218	4163	1854			2659	1612	6,6
-2,0 m kg	7212	5997	7511	3854	5892	2819	4659	2209	3559	1813			3151	1763	6,2
-3,0 m kg	7480	6088	6070	3909	4842	2853	3697	2242					3048	2050	5,5
-4,0 m kg			3876	3876	2956	2948							2372	2372	4,4
 above															
7,0 m kg			3353	3353									2536	2536	4,3
6,0 m kg			4053	3632	3310	2687							2216	2216	5,4
5,0 m kg			4203	3594	3592	2685	2590	2061					2073	1994	6,1
4,0 m kg		4736	4736	4621	3487	3535	2628	2803	2048				2016	1764	6,3
3,0 m kg		6118	4607	4459	3325	3444	2537	2756	2001				2019	1625	6,9
2,0 m kg		5749	4238	4273	3140	3339	2432	2696	1941	2221	1574		2073	1548	7,1
1,0 m kg		5490	3979	4114	2980	3241	2334	2637	1881	2192	1545		2160	1520	7,1
Ground line kg		5379	3868	4009	2876	3167	2260	2590	1834				2192	1539	6,9
-1,0 m kg	4686	4686	5350	3839	3959	2826	3125	2218	2609	1854			2295	1612	6,6
-2,0 m kg	7212	5997	5366	3854	3953	2819	3116	2209	2569	1813			2498	1763	6,2
-3,0 m kg	7480	6088	5421	3909	3987	2853	3149	2242					2881	2050	5,5
-4,0 m kg			3876	3876	2956	2948							2372	2372	4,4



COUNT ON US

1800 440 550 | prestonhire.com.au

SPECIFICATIONS

SANY SY155U

DIMENSIONS (TRANSPORT)

A	Transport length	7300 mm
B	Transport width	2590 mm
C	Upperstructure carriage	2490 mm
D	Height over cabin/ROPS	2820 mm
E	Height of Boom – transport	2755 mm
F	Overall length of crawler	3665 mm
G	Tail length	1500 mm
H	Track gauge	1990 mm
I	Undercarriage width (blade)	2590 mm
J	Horizontal distance to blade	2650 mm
K	Blade height	480 mm
L	Track height	815 mm
M	Track pads width	600 mm
N	Min. ground clearance	425 mm
O	Counterweight clearance	910 mm
P	Engine cover height	1418 mm
Q	Tail swing radius	1500 mm
R	Center distance of tumbler	2930 mm

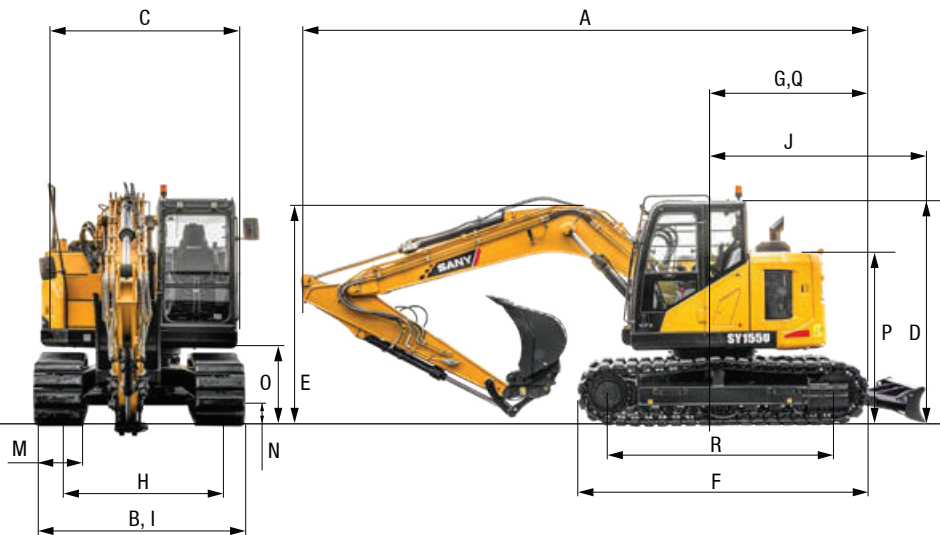

WORKING AREA

A	Max. digging reach	8338 mm
B	Max. digging depth	5468 mm
C	Max. digging height	9218 mm
D	Max. dumping height	6756 mm
E	Min. dumping height	2920 mm
F	Max. vertical digging depth	3796 mm
G	Overall height over arm by min. swing radius	6749 mm
H	Arm head distance with work equipment retracted as far as possible	2650 mm
I	Min. swing radius	2086 mm
J	Max. clearance when blade up	504 mm
K	Max. depth of blade down	350 mm

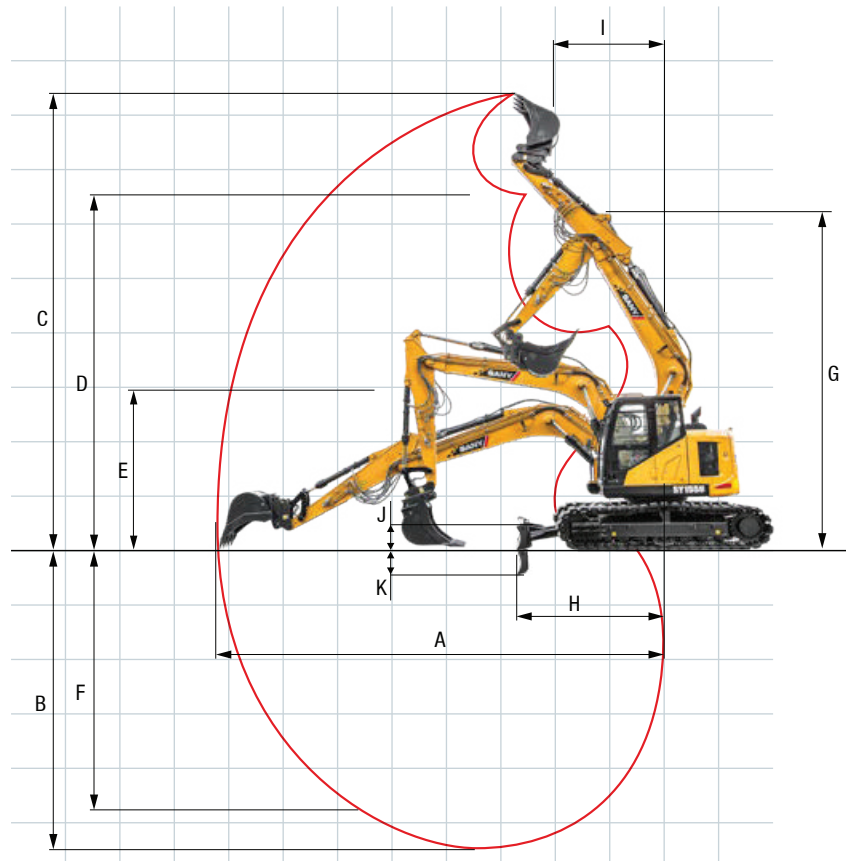



Auckland

Christchurch



SPECIALISED EQUIPMENT HIRE SOLUTIONS

Branch Locations

North Island

31 Patiki Rd,
Avondale, Auckland 1026
nzsales@prestonhire.co.nz

South Island

984 Shands Road,
Prebbleton, Christchurch 7676
nzsales@prestonhire.co.nz

**Service Areas Including: Queenstown and Dunedin*

***Preston Hire available across Oceania*



COUNT ON US

0800 440 558 | prestonhire.co.nz