

SENNEBOGEN 653R

- Max. hoist height - 30.4m
- Max. radius - 26.0m

- Maximum Rated Capacity - 50.t
- Main Telescopic Boom - 30.4m
- Telescopic Boom + Fly Jib - 43.4m

- Climatised cabin enclosed
- Maxicabin tilt cabin



The Sennebogen 653R hydraulic crawler has a lifting capacity up to max. 50 t, telescopic boom to 30,4 m. Robust telescopic system inside the Full-Power Boom, telescopic function can even be used under load. Simple and easy transportation, ready to use quickly. Maximum extension of 13 m with folding jib. Can be used with a second hook on the boom head and heavy duty top. Consider the possibilities...

SPECIFICATIONS

SENNEBOGEN 653R

DIMENSIONS

Length	10,700mm
Width 3000mm (retracted)	4500mm (extended)
Height	3180mm
Weight	50200kg

CAPACITY

Max. capacity	50000kg at 2.0m
Max. working radius (main boom)	2200kg at 26.0m
Max. working radius (fly jib)	600kg at 34.0m
Max. lifting height (main boom)	30.4m
Max. lifting height (fly jib)	43.4m

TRACK

Width	700mm
-------	-------

MIN. TRANSPORT WIDTH

Overall Track	3000mm
Overall Unit	3000mm

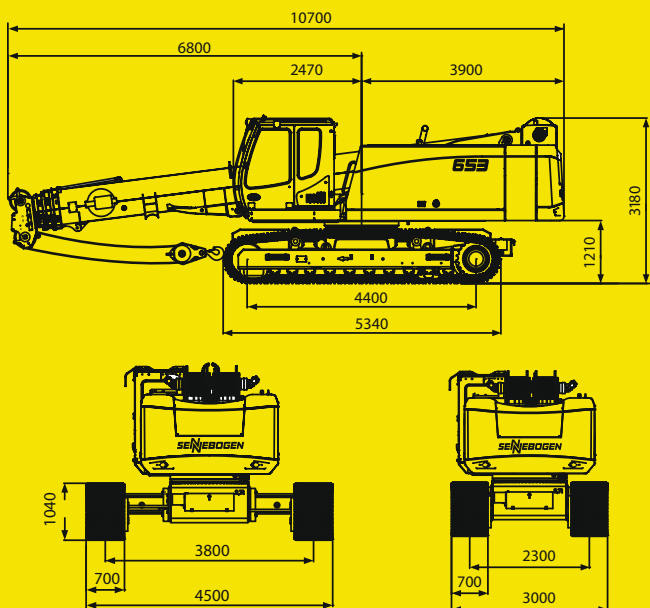

WORKING RANGE

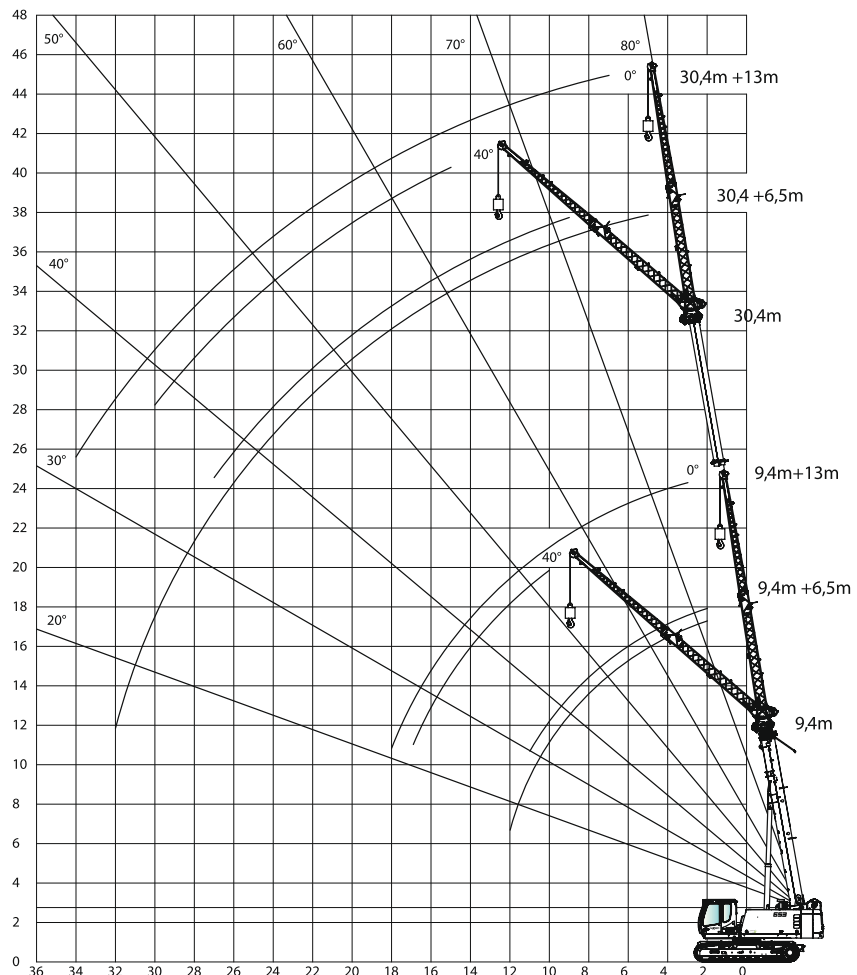
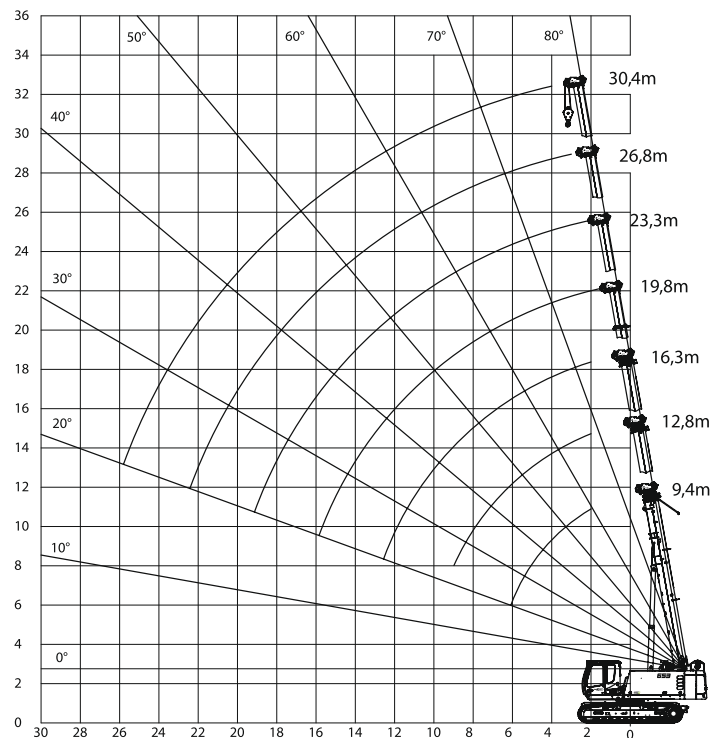

LOAD CHART

SENNEBOGEN 653R

LOAD CHART

30.4 main boom

	Boom length [m]																					
	9.4			12.8			16.3			19.8			23.3			26.8			30.4			
Counterweight [t]																						
Undercarriage ballast [t]																						
Undercarriage track width [m]																						
Outreach [m]																						
2.0	50.0	40.0	35.0	31.0	31.0	30.0	26.0	26.0	20.0	15.6	15.6	15.6	14.5	14.5	14.5							
3.0	45.0	40.0	35.0	31.0	31.0	30.0	24.4	24.4	20.0	15.6	15.6	15.6	14.5	14.5	14.5	12.7	12.7	12.7				
4.0	38.0	30.0	24.0	31.0	30.0	22.7	21.7	21.7	20.0	15.6	15.6	15.6	14.5	14.5	14.5	12.6	12.6	12.6	9.2	9.2	9.2	
5.0	30.0	22.5	17.0	28.0	22.6	17.3	19.3	19.3	16.0	15.6	15.6	15.5	14.2	14.2	14.2	12.4	12.4	12.4	9.2	9.2	9.2	
6.0	22.0	17.0	13.0	22.3	17.0	13.2	16.9	16.6	12.8	14.9	14.9	12.6	13.6	13.6	12.3	11.9	11.9	11.9	9.2	9.2	9.2	
7.0				17.3	13.4	10.4	15.0	13.3	10.3	13.6	13.4	10.4	12.5	12.5	10.2	11.1	11.1	10.0	9.1	9.1	9.1	9.1
8.0				14.2	10.9	8.4	13.3	10.8	8.3	12.2	11.2	8.7	11.1	11.2	8.7	10.3	10.3	8.6	8.7	8.7	8.7	8.4
9.0				11.5	9.0	7.0	11.5	8.9	6.9	11.1	9.3	7.3	10.2	9.6	7.5	9.4	9.4	7.4	8.2	8.2	8.2	7.3
10.0							9.7	7.5	5.8	9.9	7.9	6.1	9.3	8.2	6.4	8.6	8.3	6.4	7.8	7.8	7.8	6.4
11.0							8.3	6.4	4.9	8.7	6.8	5.2	8.5	7.0	5.5	8.0	7.2	5.6	7.3	7.3	7.3	5.6
12.0							7.2	5.5	4.1	7.5	5.9	4.5	7.7	6.1	4.7	7.3	6.3	4.9	6.8	6.4	6.4	5.0
13.0							6.2	4.7	3.5	6.6	5.1	3.9	6.9	5.4	4.1	6.8	5.5	4.3	6.4	5.7	5.7	4.4
14.0										5.8	4.5	3.4	6.0	4.7	3.6	6.1	4.9	3.8	5.9	5.0	5.0	3.9
15.0										5.2	3.9	2.9	5.4	4.2	3.2	5.6	4.4	3.3	5.6	4.5	4.5	3.5
16.0										4.6	3.5	2.5	4.8	3.7	2.8	5.0	3.9	2.9	5.0	4.0	4.0	3.1
17.0													4.3	3.3	2.4	4.5	3.5	2.6	4.7	3.6	3.6	2.7
18.0													3.9	2.9	2.1	4.1	3.1	2.3	4.2	3.2	3.2	2.4
19.0													3.5	2.6	1.8	3.7	2.8	2.0	3.9	2.9	2.9	2.1
20.0													3.1	2.3	1.5	3.4	2.5	1.7	3.5	2.6	2.6	1.9
21.0																3.1	2.2	1.5	3.2	2.4	2.4	1.6
22.0																2.8	2.0	1.3	2.9	2.1	2.1	1.4
23.0																2.5	1.8	1.1	2.7	1.9	1.9	1.2
24.0																			2.4	1.7	1.7	1.1
25.0	Table no.: 653R-75/1977/8.9+5.5/10.14 HA 0.3°																		2.2	1.5	1.5	0.9
26.0	Table no.: 653R-75/1577/8.9+5.5/10.14 HA 0.3°																		2.0	1.3	1.3	0.7
26.0	Table no.: 653R-75/1227/8.9+5.5/10.14 HA 0.3°																					
Number of strands	4	10	10	3	8	8	3	6	6	2	4	4	2	4	4	2	4	4	1	4	4	
I	0%			50%			100%			100%			100%			100%			100%			
II	0%			0%			0%			25%			50%			75%			100%			
III	0%			0%			0%			25%			50%			75%			0%			
Load capacity reduction [kg]	580			420			330			270			230			200			180			
180	-																					



COUNT ON US











1800 440 550 | prestonhire.com.au

LOAD CHART

SENNEBOGEN 653R

LOAD CHART

6.5m fly jib

 8.9t  5.5t	Telescopic boom length [m]							
	9.4		16.3		23.8		30.3	
 3.8 m	 0°	 40°	 0°	 40°	 0°	 40°	 0°	 40°
Outreach [m]								
2.0	10.0							
3.0	9.9		10.0		9.9			
4.0	8.6		9.9		9.4			
5.0	7.7	4.6	9.4		9.0		4.9	
6.0	6.9	4.4	8.7	4.6	8.5		4.8	
7.0	6.3	4.2	8.0	4.5	8.0	4.4	4.8	
8.0	5.7	4.0	7.4	4.3	7.6	4.3	4.7	
9.0	5.2	3.9	6.9	4.2	7.2	4.2	4.7	4.0
10.0	4.8	3.8	6.4	4.1	6.8	4.1	4.7	4.0
11.0	4.5	3.7	6.0	4.0	6.5	4.0	4.7	3.9
12.0	4.1		5.7	3.9	6.2	3.9	4.7	3.8
13.0			5.3	3.8	5.9	3.9	4.6	3.8
14.0			5.0	3.8	5.7	3.8	4.4	3.7
15.0			4.8	3.7	5.4	3.7	4.2	3.7
16.0			4.6	3.7	5.0	3.7	4.0	3.6
17.0			4.2		4.6	3.6	3.8	3.5
18.0			4.0		4.2	3.6	3.7	3.4
19.0					3.7	3.6	3.5	3.3
20.0					3.5	3.5	3.4	3.2
21.0					3.2	3.3	3.2	3.1
22.0					2.9		3.0	3.0
23.0					2.6		2.7	2.8
24.0					2.4		2.4	2.6
25.0							2.2	2.4
26.0							2.0	2.2
27.0							1.8	2.0
28.0							1.7	
29.0							1.5	
30.0							1.4	
31.0							1.2	
32.0							1.1	
33.0	Table no.: 653R-75/2327/8.9+0.0/10.14 SA6.5 0.3°							
34.0								
Number of strands	2	1	2	1	2	1	2	1
I	0%		100%		100%		100%	
II	0%		0%		50%		100%	
III	0%		0%		50%		100%	

LOAD CHART

SENNEBOGEN 653R

LOAD CHART

13m fly jib

8.9 t	5.5 t	Telescopic boom length [m]							
		9.4		16.3		23.8		30.3	
3.8 m	0°	40°	0°	40°	0°	40°	0°	40°	
Outreach [m]									
2.0									
3.0	4.6								
4.0	4.4		4.6						
5.0	4.0		4.4		3.8				
6.0	3.7		4.1		3.7				
7.0	3.4		3.8		3.6		2.1		
8.0	3.1		3.6		3.4		2.1		
9.0	2.9		3.4		3.3		2.1		
10.0	2.7	1.8	3.2		3.1		2.1		
11.0	2.5	1.7	3.0		3.0		2.1		
12.0	2.3	1.7	2.8	1.7	2.9		2.1		
13.0	2.2	1.7	2.6	1.7	2.7	1.7	2.1		
14.0	2.0	1.6	2.5	1.7	2.6	1.6	2.1		
15.0	1.9	1.6	2.4	1.6	2.5	1.6	2.1	1.5	
16.0	1.8	1.5	2.3	1.6	2.4	1.6	2.1	1.5	
17.0	1.7	1.5	2.1	1.5	2.3	1.5	2.1	1.5	
18.0	1.6		2.0	1.5	2.2	1.5	2.1	1.5	
19.0			2.0	1.5	2.1	1.5	2.0	1.4	
20.0			1.9	1.5	2.1	1.5	2.0	1.4	
21.0			1.8		2.0	1.4	1.9	1.4	
22.0			1.7		1.9	1.4	1.9	1.4	
23.0			1.6		1.8	1.4	1.8	1.4	
24.0			1.5		1.8	1.4	1.8	1.3	
25.0					1.7	1.4	1.7	1.3	
26.0					1.7	1.4	1.7	1.3	
27.0					1.6		1.6	1.3	
28.0					1.4		1.6	1.3	
29.0					1.4		1.6	1.3	
30.0							1.3	1.1	
31.0							1.1		
32.0							0.9		
33.0	Table no.: 653R-75/1977/8.9+5.5/10.14 SA13 0.3*						0.7		
34.0							0.6		
Number of strands	2	1	2	1	2	1	2	1	
I	0%		100%		100%		100%		
II	0%		0%		50%		100%		
III	0%		0%		50%		100%		



SPECIALISED EQUIPMENT HIRE SOLUTIONS

Branch Locations

NSW/ACT

25-39 Chadderton Street,
Cabramatta NSW 2166
nswsales@prestonhire.com.au

NSW

56 Sandringham Place,
Thornton, NSW, 2322
nswsales@prestonhire.com.au

QLD

83 Parramatta Road,
Underwood, QLD 4119
qldsales@prestonhire.com.au

VIC/TAS

38 Sunline Dr,
Truganina, VIC 3029
vicsales@prestonhire.com.au

WA/NT

Unit 2,8 Hunt Street,
Malaga, WA 6090
wasales@prestonhire.com.au

SA

102 Cormack Road,
Wingfield, SA 5013
sasales@prestonhire.com.au

**Preston Hire available across Oceania*



COUNT ON US

1800 440 550 | prestonhire.com.au